

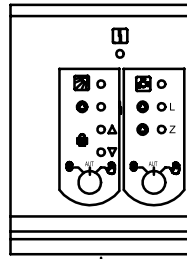











 Tensiune de comandă 230 V
 Tensiune joasă



Poziție comutator	 k4	k6
		regim automat
AUT	regim automat pompă	
		

Poziție comutator	 k1	k2	k3
			
AUT	regim automat pompă	regim automat răcire	regim automat încălzire
			

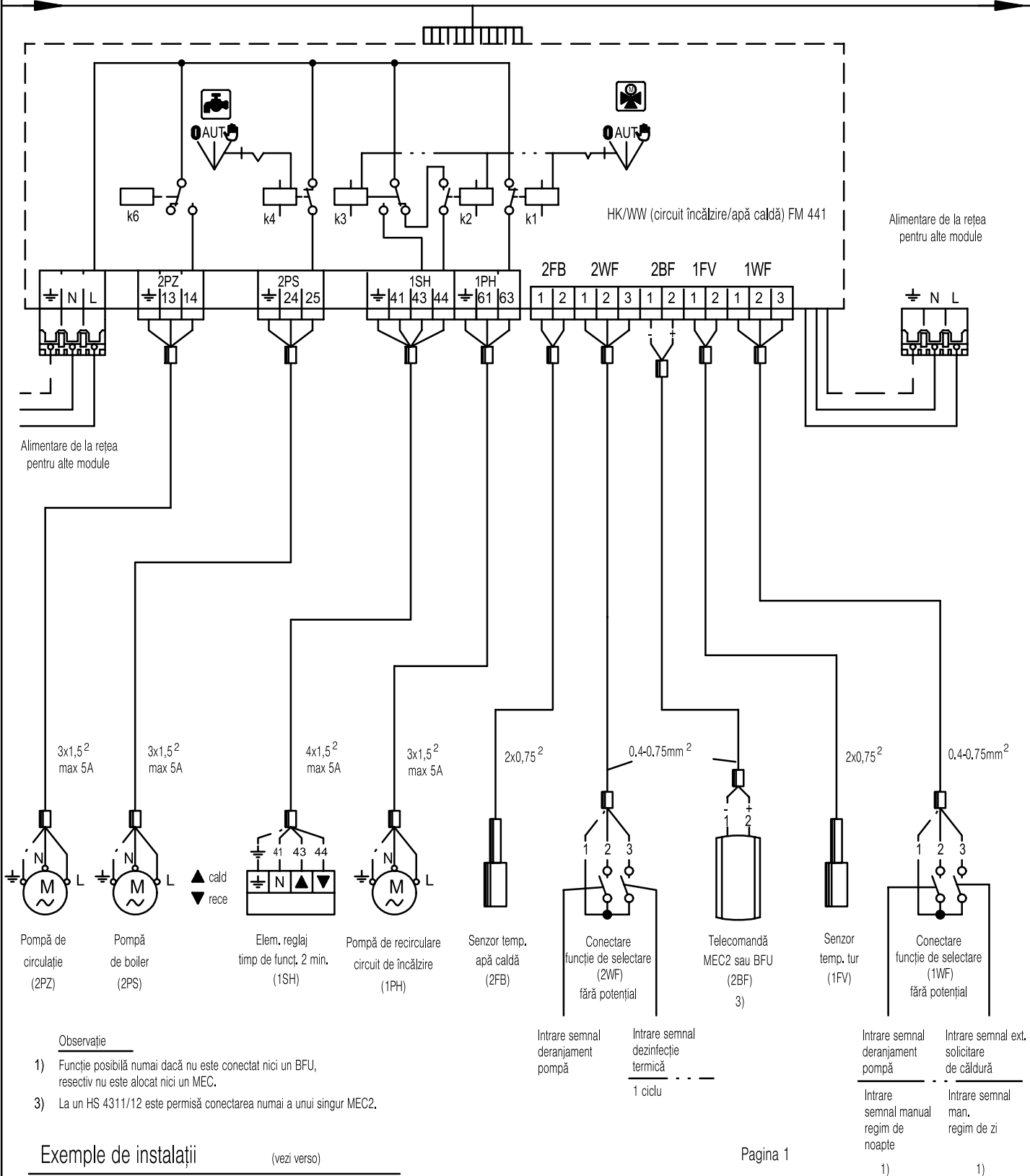

Observație

- 1) Funcție posibilă numai dacă nu este conectat nici un BFU, respectiv nu este alocat nici un MEC.
- 3) La un HS 4311/12 este permisă conectarea numai a unui singur MEC2.

Exemple de instalații

(vezi verso)

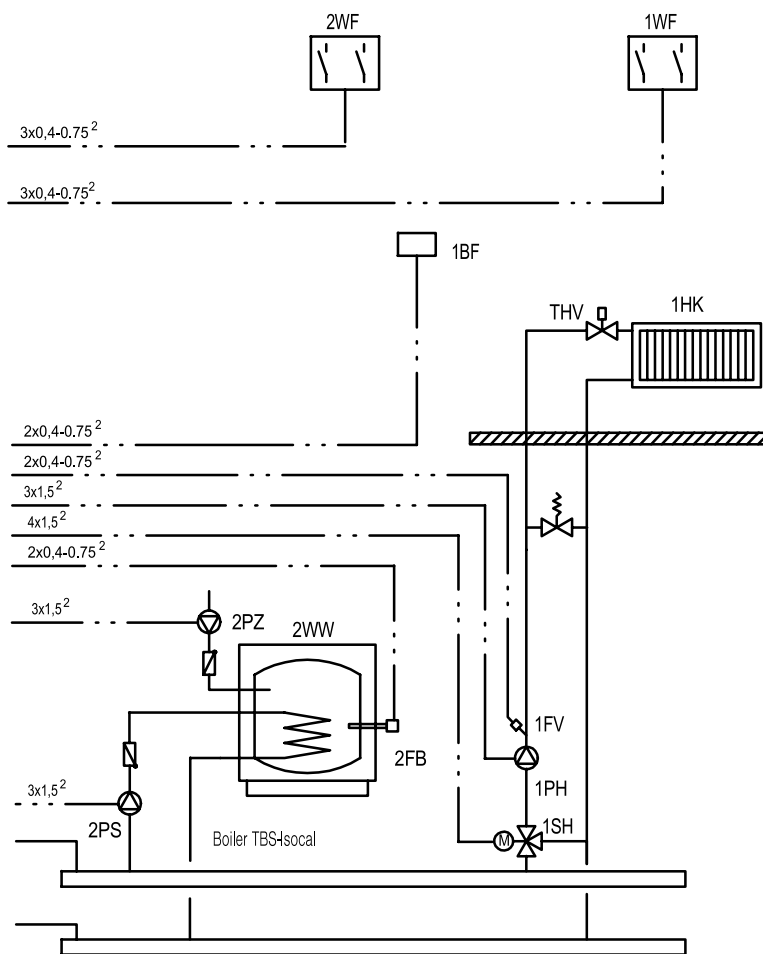

THV Ventil termostat radiator
 HK Circuit de încălzire
 WW Preparare apă caldă